



Sàn gỗ nhựa hèm khóa SPC



Tấm ốp tường/trần Nano



Tấm ốp lam sóng



Phào chỉ trang trí



BẢNG BÁO GIÁ

Gỗ Nhựa Nội Thất



BUILDING MATERIALS CORPORATION

Sàn Gỗ Nhựa Hèm Khóa SPC

Không gian lắp đặt: phòng khách, phòng bếp, phòng ngủ, cầu thang, hành lang, trung tâm thương mại

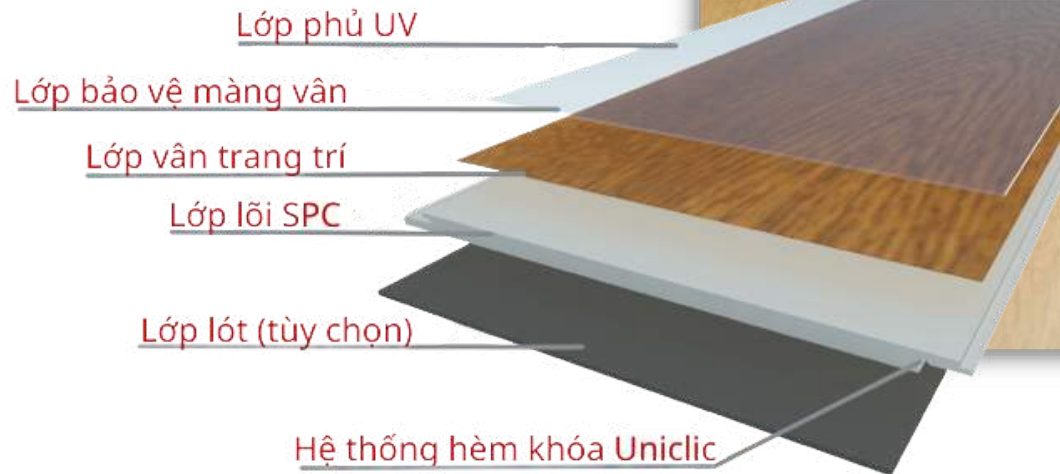



EF1001



EF1002



EF1003



EF1004

(16 thanh/thùng ~ 2.16m²)	4.3*150*900mm (không đệm)	4.3*150*900mm (xương cá)
M2 sàn	340.000đ	360.000đ
M2 thi công hoàn thiện	399.000đ	470.000đ

**Giá hoàn thiện gồm nhân công và phụ kiện len A, nẹp F kết thúc sàn. Nếu dùng phào chân tường SPC thêm 35k/m². Nghiệm thu theo m² thực tế.*



EF2001



EF2002



EF3001



EF3002

Kích Thước	5.3*180*1220mm (có đệm)	7*230*1220mm (có đệm)
Số Lượng	10 thanh/thùng ~ 2.196m ²	8 thanh/thùng ~ 2.2448m ²
M2 sàn	355.000đ	455.000đ
M2 thi công hoàn thiện	399.000đ	499.000đ

*Giá hoàn thiện gồm nhân công và phụ kiện len A, nẹp F kết thúc sàn. Nếu dùng phào chân tường SPC thêm 35k/m². Nghiệm thu theo m² thực tế.



EF1101



EF1102



EF1201



EF4001



EF5001

Kích Thước	5.3*180*1220mm (có đệm)	7*230*1220mm (có đệm)
Số Lượng	10 thanh/thùng ~ 2.196m ²	8 thanh/thùng ~ 2.2448m ²
M2 sàn	355.000đ	455.000đ
M2 thi công hoàn thiện	399.000đ	499.000đ

**Giá hoàn thiện gồm nhân công và phụ kiện len A, nẹp F kết thúc sàn. Nếu dùng phào chân tường SPC thêm 35k/m². Nghiệm thu theo m² thực tế.*

**EF9001****EF9002**

Kích Thước	4.3*300*600mm (không đệm)
Số Lượng	12 thanh/thùng ~ 2.16m ²
M2 sàn	340.000đ
M2 thi công hoàn thiện	399.000đ

**Giá hoàn thiện gồm nhân công và phụ kiện len A, nẹp F kết thúc sàn. Nếu dùng phào chân tường SPC thêm 35k/m². Nghiệm thu theo m² thực tế.*



SA 11



SA 12



SA 14



SA 15

(7 thanh/thùng
~ 1.56282m²)

7.5*183*1220 mm (có đệm dày 1.5mm)

M2 sàn

490.000đ

M2 thi công hoàn thiện

560.000đ

**Giá hoàn thiện gồm nhân công và phụ kiện len A, nẹp F kết thúc sàn. Nếu dùng phào chân tường SPC thêm 35k/m². Nghiệm thu theo m² thực tế.*



SA 16



SA 17



SA 18



SA 61

(7 thanh/thùng
 ~ 1.56282m²)

7.5*183*1220 mm (có đệm dày 1.5mm)

M2 sàn

490.000đ

M2 thi công hoàn thiện

560.000đ

**Giá hoàn thiện gồm nhân công và phụ kiện len A, nẹp F kết thúc sàn. Nếu dùng phào chân tường SPC thêm 35k/m². Nghiệm thu theo m² thực tế.*



SA 110



SA 122



SA 264



SA 308

(7 thanh/thùng
~ 1.56282m²)

7.5*183*1220 mm (có đệm dày 1.5mm)

M2 sàn

490.000đ

M2 thi công hoàn thiện

560.000đ

**Giá hoàn thiện gồm nhân công và phụ kiện len A, nẹp F kết thúc sàn. Nếu dùng phào chân tường SPC thêm 35k/m². Nghiệm thu theo m² thực tế.*



Tấm ốp Lam Sóng

Vị trí lắp đặt: tường, trần, vách ngăn, lamri,....

Màng vân trang trí chất lượng cao

Nguyên liệu an toàn từ bột đá siêu mịn và nhựa nguyên sinh



57A



43A



26A



03A



34A



44A



37A

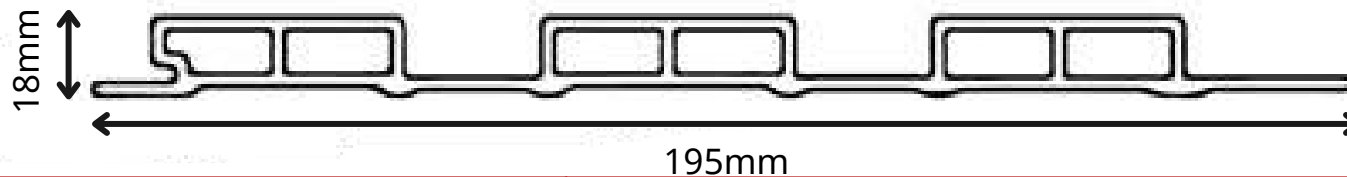

18*195*3000 mm
(0.585 m²/tấm)

M2

Tấm

M2 thi công hoàn thiện

540.000đ

315.000đ

860.000đ

*Giá hoàn thiện gồm nhân công và phụ kiện, len nẹp kết thúc. Nghiệm thu theo m² thực tế.



W063



M012



9833



8782



S021



M022



W247



8626



9042



M004

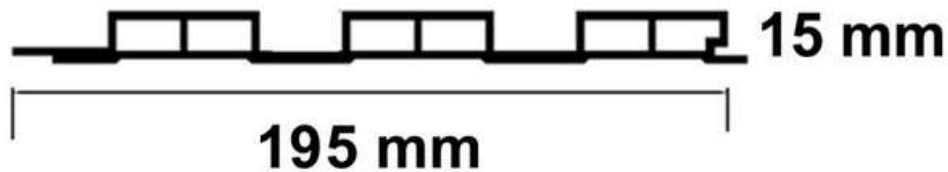

15*195*3000 mm
(0.585 m²/tấm)

M2

Tấm

M2 thi công hoàn thiện

520.000đ

304.000đ

840.000đ

*Giá hoàn thiện gồm nhân công và phụ kiện, len nẹp kết thúc. Nghiệm thu theo m² thực tế.



W063



M012



9833



8782



8695



M024



W247



8626



9042



M004

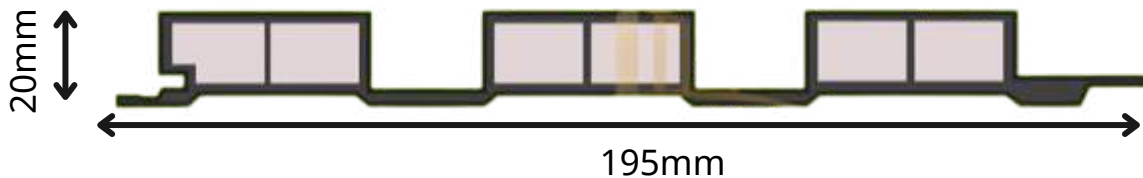

20*195*3000 mm
(0.585 m²/tấm)

M2

Tấm

M2 thi công hoàn thiện

540.000đ

316.000đ

860.000đ

*Giá hoàn thiện gồm nhân công và phụ kiện, len nẹp kết thúc. Nghiệm thu theo m² thực tế.



9833



M024



M012



M022



8782



W063



W247

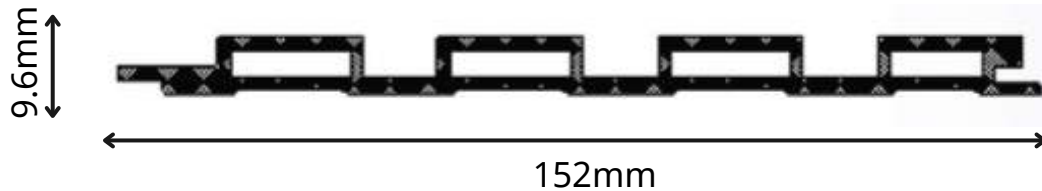

9.6*152*3000 mm
(0.456 m²/tấm)

M2	Tấm	M2 thi công hoàn thiện
490.000đ	223.000đ	810.000đ

*Giá hoàn thiện gồm nhân công và phụ kiện, len nẹp kết thúc. Nghiệm thu theo m² thực tế.

Lam 4 Sóng Cao



9042



8695



8782



8829



8626



W026



W160



W056



W096

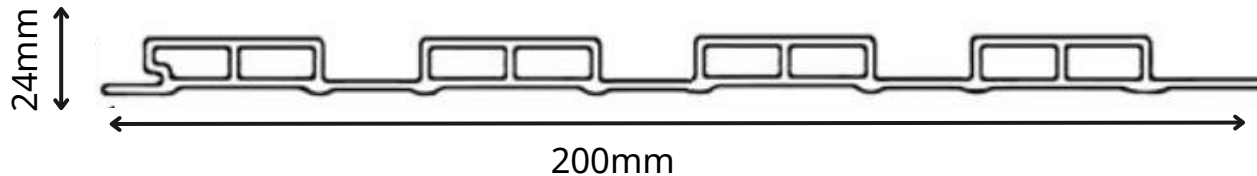

24*200*3000 mm
(0.6 m²/tấm)

M2

Tấm

M2 thi công hoàn thiện

660.000đ

396.000đ

990.000đ

*Giá hoàn thiện gồm nhân công và phụ kiện, len nẹp kết thúc. Nghiệm thu theo m² thực tế.



57A



43A



26A



03A



34A



44A



37A

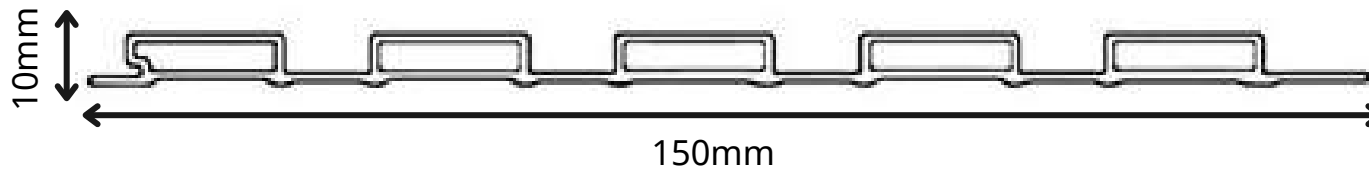

10*150*3000 mm
(0.45 m²/tấm)

M2	Tấm	M2 thi công hoàn thiện
530.000đ	239.000đ	850.000đ

*Giá hoàn thiện gồm nhân công và phụ kiện, len nẹp kết thúc. Nghiệm thu theo m² thực tế.



57A



43A



26A



03A



34A



44A



37A

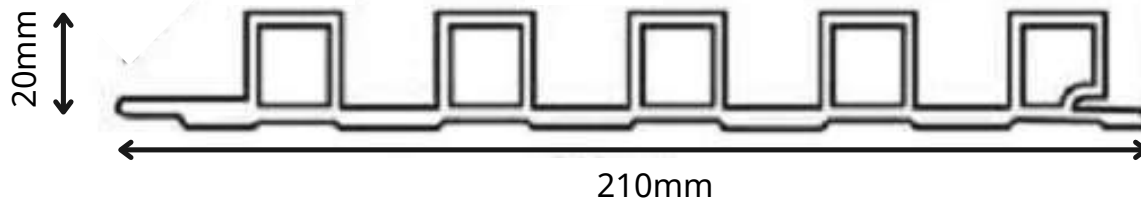

20*210*3000 mm
(0.63 m²/tấm)

M2

Tấm

M2 thi công hoàn thiện

550.000đ

347.000đ

880.000đ

*Giá hoàn thiện gồm nhân công và phụ kiện, len nẹp kết thúc. Nghiệm thu theo m² thực tế.



M004

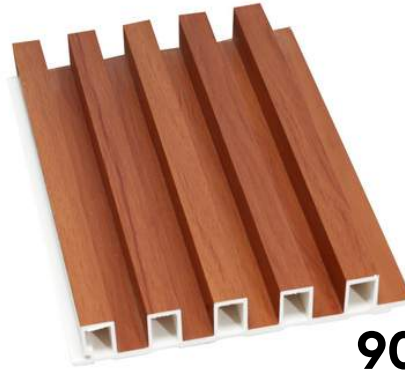

9018



8695

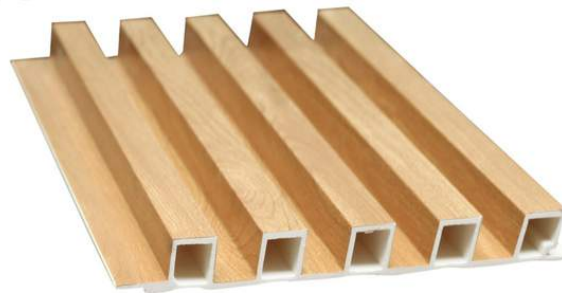

W247



W063

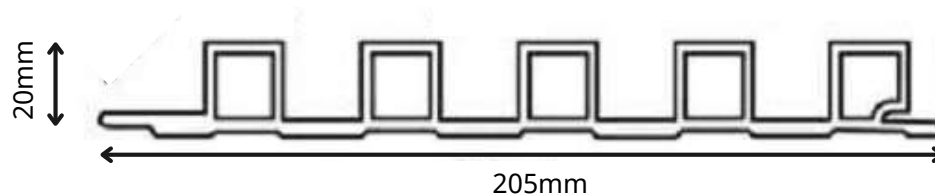

20*205*3000 mm
(0.615 m²/tấm)

M2

Tấm

M2 thi công hoàn thiện

550.000đ

338.000đ

880.000đ

*Giá hoàn thiện gồm nhân công và phụ kiện, len nẹp kết thúc. Nghiệm thu theo m² thực tế.



W096



9046



W056



W160



M022

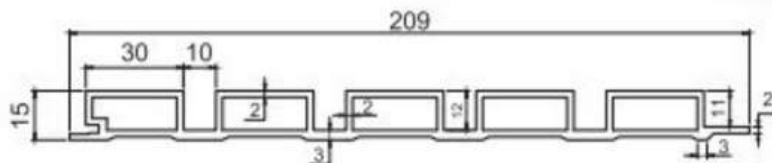

15*209*3000 mm
(0.627 m²/tấm)

M2

Tấm

M2 thi công hoàn thiện

540.000đ

316.000đ

860.000đ

*Giá hoàn thiện gồm nhân công và phụ kiện, len nẹp kết thúc. Nghiệm thu theo m² thực tế.



M012



M022



8626



9006

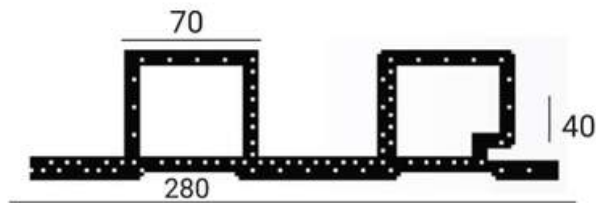

40*280*3000 mm
(0.84 m²/tấm)

M2

Tấm

M2 thi công hoàn thiện

680.000đ

571.000đ

980.000đ

*Giá hoàn thiện gồm nhân công và phụ kiện, len nẹp kết thúc. Nghiệm thu theo m² thực tế.



M004



M012



9006



9018



9042



M024

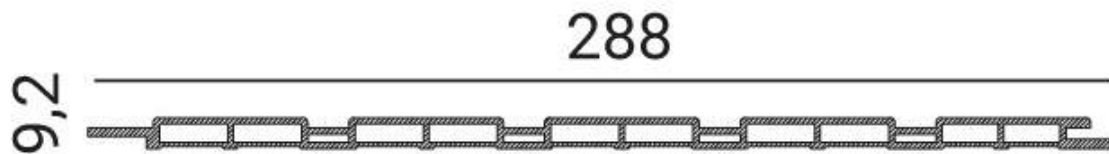

9.2*288*3000 mm
(0.864 m²/tấm)

M2	Tấm	M2 thi công hoàn thiện
480.000đ	415.000đ	795.000đ

*Giá hoàn thiện gồm nhân công và phụ kiện, len nẹp kết thúc. Nghiệm thu theo m² thực tế.



BUILDING MATERIALS CORPORATION

Tấm ốp Nano

Vị trí lắp đặt: tường, trần, vách ngăn, lamri, tủ....



Màng vân trang trí chất lượng cao

Nguyên liệu an toàn từ bột đá siêu mịn và nhựa nguyên sinh

Cấu trúc ô rỗng giúp cách âm và cách nhiệt tốt

Kết cấu hèm khóa giúp dễ dàng lắp đặt trên mọi bề mặt



26A



34A



43A



37A



44A



03A

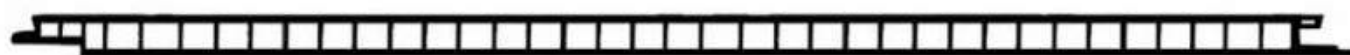

Dài 3000 mm/ Tấm

	6*300*3000mm (0.9m²)	8*400*3000mm (1.2m²)	8*600*3000 mm (1.8m²)
M2	285.000đ	324.000đ	350.000đ
Tấm	257.000đ	389.000đ	630.000đ
M2 thi công hoàn thiện	565.000đ	610.000đ	650.000đ

*Giá hoàn thiện gồm nhân công và phụ kiện, len nẹp kết thúc. Nghiệm thu theo m² thực tế.



31A

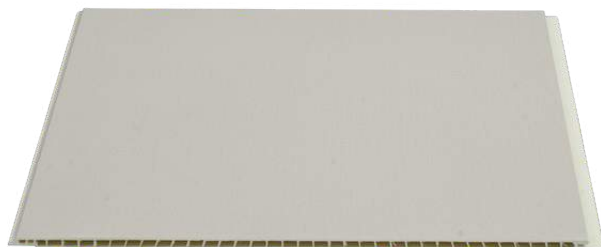

04A



01C



25A



23A



20A



Dài 3000 mm/ Tấm

	6*300*3000mm (0.9m²)	8*400*3000mm (1.2m²)	8*600*3000 mm (1.8m²)
M2	285.000đ	324.000đ	350.000đ
Tấm	257.000đ	389.000đ	630.000đ
M2 thi công hoàn thiện	565.000đ	610.000đ	650.000đ

*Giá hoàn thiện gồm nhân công và phụ kiện, len nẹp kết thúc. Nghiệm thu theo m² thực tế.



13A



10A



52A

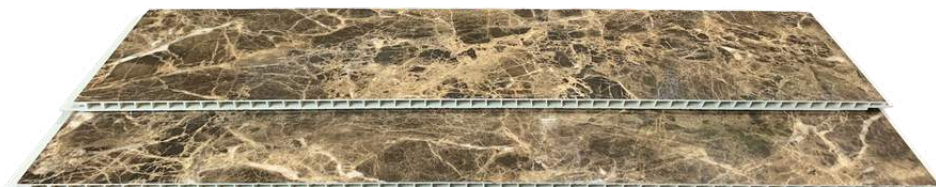

07A



17A

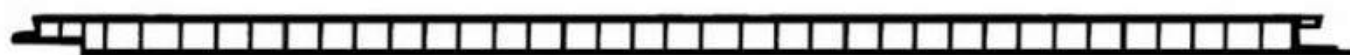

Dài 3000 mm/ Tấm

6*300*3000mm (0.9m²)

8*400*3000mm (1.2m²)

8*600*3000 mm (1.8m²)

M2

285.000đ

324.000đ

350.000đ

Tấm

257.000đ

389.000đ

630.000đ

**M2 thi công
hoàn thiện**

565.000đ

610.000đ

650.000đ

*Giá hoàn thiện gồm nhân công và phụ kiện, len nẹp kết thúc. Nghiệm thu theo m² thực tế.



9018



M024



W063



W247



M022



9833



S021



P81

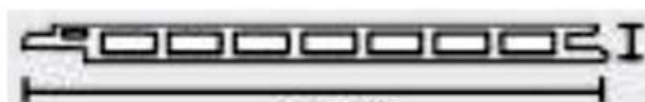

9,2 mm

400 mm

9.2*400*3000mm
(1.2 m²/tấm)

M2

Tấm

M2 thi công hoàn thiện

424.000đ

509.000đ

730.000đ

*Giá hoàn thiện gồm nhân công và phụ kiện, len nẹp kết thúc. Nghiệm thu theo m² thực tế.



M012



Q027



8695



8782



W247



9833



9,2 mm

9.2*100*3000mm
(0.3 m²/tấm)

M2

Tấm

M2 thi công hoàn thiện

480.000đ

144.000đ

775.000đ

*Giá hoàn thiện gồm nhân công và phụ kiện, len nẹp kết thúc. Nghiệm thu theo m² thực tế.

TRẦN PHẪNG NANO



850.000đ/m²

TRẦN GIẬT CẤP NANO



850.000đ/m²

TRẦN PHẪNG LAM SÓNG



1.000.000đ/m²

TRẦN GIẬT CẤP (Ngoài lam trong phẳng)



950.000đ/m²

TRẦN GIẬT CẤP (Full 4 sóng thấp)



1.200.000đ/m²

TRẦN GIẬT CẤP (Full 5 sóng thấp Anpro)



1.400.000đ/m²

LAMRI TẤM ỐP NANO



780.000đ/m²

LAMRI TẤM T100



850.000đ/m²

LAMRI LAM SÓNG



950.000đ/m²

LƯU Ý

- Giá hoàn thiện đã bao gồm vật tư, nhân công và phụ kiện, len nẹp kết thúc
- Giá hoàn thiện chưa bao gồm khung xương
- Lamri lam sóng áp dụng cho cả 4 loại: 3 sóng, 4 sóng thấp, 5 sóng thấp, 5 sóng cao
- Giá hoàn thiện áp dụng cho chiều cao lamri lỗ khổ như: 0.75m, 1.2m, 1.3m
- Nghiệm thu theo m² thực tế



Tấm Vách Ngăn

Vị trí lắp đặt: phòng khách, phòng ngủ, phòng bếp, nhà vệ sinh, phòng thờ,....



9006



M024



8626



9833

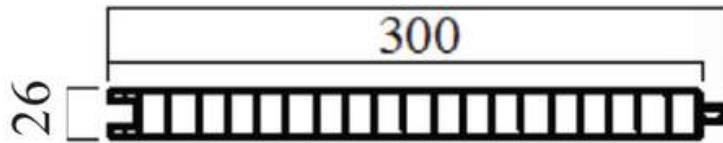

26*300*3000mm
(0.9 m²/tấm)

M2

Tấm

M2 thi công hoàn thiện

950.000đ

866.000đ

1.350.000đ

*Giá hoàn thiện gồm nhân công và phụ kiện phào. Nghiệm thu theo m² thực tế.

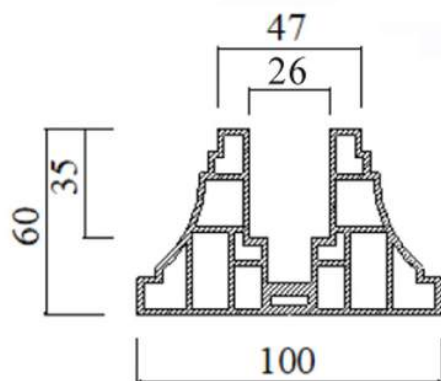

60*100*3000mm

Mét dài

159.000đ

Thanh

477.000đ

Thanh Lam Hộp Trang Trí

Vị trí lắp đặt: làm vách ngăn,
làm bình phong, trần lam treo....





M012



9042



W063



M004



9833

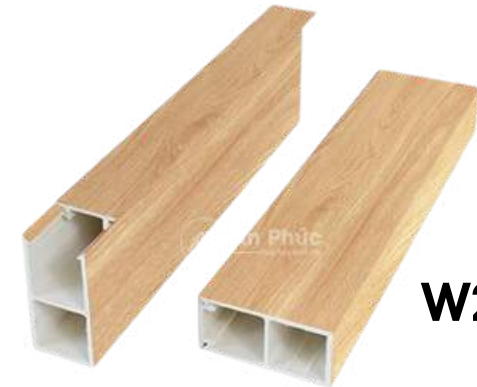

W247

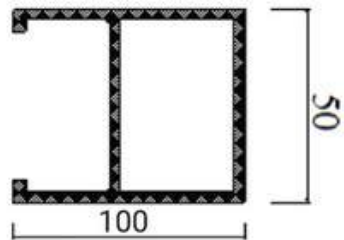

50*100*3600mm

Mét dài

168.000đ

Thanh

605.000đ

Md thi công hoàn thiện

350.000đ

**Giá hoàn thiện gồm nhân công và phụ kiện phào chỉ. Nghiệm thu theo md thực tế.*



M012



9042



8626



M022



M044

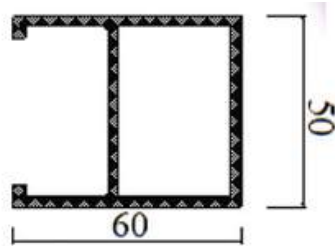

50*60*3000mm

Mét dài

129.000đ

Thanh

387.000đ

Md thi công hoàn thiện

250.000đ



80*180*3000mm



Mét dài

600.000đ

Thanh

1.800.000đ



**Giá hoàn thiện gồm nhân công và phụ kiện. Nghiệm thu theo mẫu thực tế.*



BUILDING MATERIALS CORPORATION



Bậc Cầu Thang

MẶT BẬT CẦU THANG	CỔ BẠC CẦU THANG	PHÀO 36	PHÀO 80
			
22 x 300 x 2400 mm	10 x 200 x 2400 mm	22 x 36 x 2400 mm	22 x 80 x 2400 mm
745.000đ/thanh	410.000đ/thanh	210.000đ/thanh	255.000đ/thanh



M2 thi công hoàn thiện
1.700.000đ/m2



BUILDING MATERIALS CORPORATION



Tranh 3D PVC Phủ Ceramic

Vị trí lắp đặt: phòng khách,
phòng ngủ, phòng bếp,....

CRC[®] Tranh 3D PVC Phủ Ceramic

BUILDING MATERIALS CORPORATION

Tranh khung treo



Khung nhựa cao cấp

1.100.000đ/m²

Khung hợp kim nhôm cao cấp

1.800.000đ/m²



Tranh 3D PVC Phủ Ceramic

Tranh in theo khổ



	3*1220*2440mm	3*1220*3000mm
M2 tấm	850.000đ	950.000đ
M2 thi công hoàn thiện	1.250.000đ	1.350.000đ

**Đơn giá hoàn thiện đã bao gồm nhân công, nẹp/chỉ, tấm lót tranh MDF/ván ép phủ phim*



Tấm ốp PVC Vân đá

Vị trí lắp đặt: tường, trần, vách ngăn, lamri, tủ....

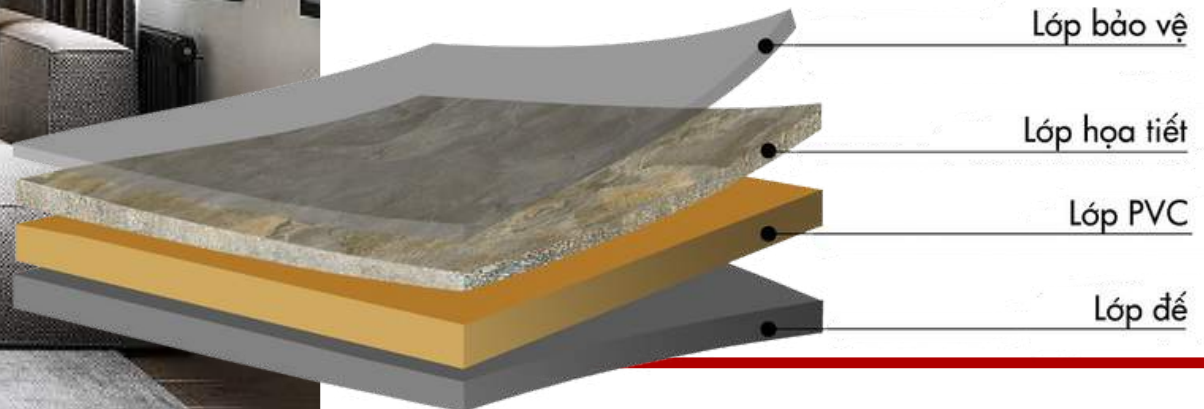

Tấm Ốp PVC Vân Đá



PVC 9640



PVC 9641



PVC 9626



PVC 9605



PVC 9655



PVC 9657



PVC 9617



PVC 9607



PVC 9625



PVC 9614

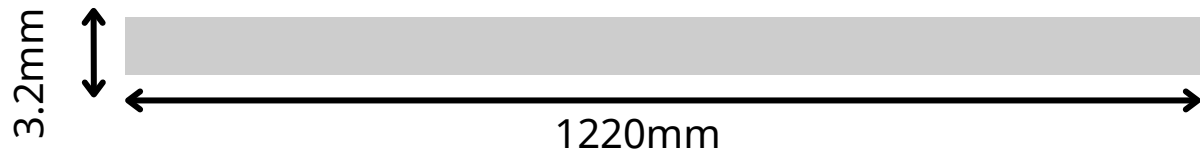

1220*2440 mm
(2.9768 m²/tấm)

	Dày 2.8 mm	Dày 3.2 mm
M2 tấm	495.000đ	595.000đ
M2 thi công hoàn thiện	450.000đ	450.000đ

*Đơn giá hoàn thiện đã bao gồm nhân công, nẹp/chỉ, tấm lót tranh MDF/ván ép phủ phim



BUILDING MATERIALS CORPORATION

Phào Chỉ Trang Trí

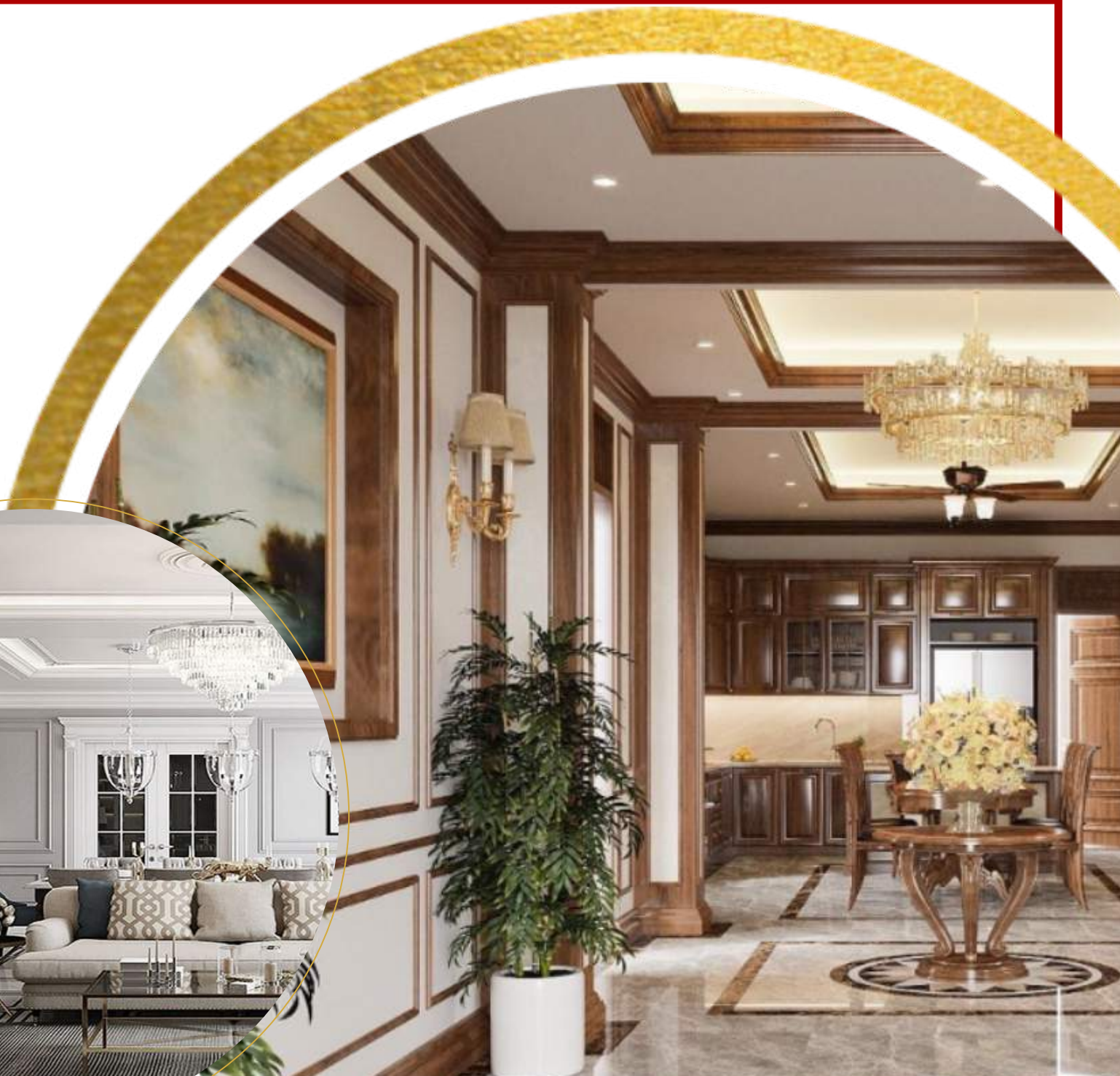



Phào Chỉ Trang Trí PS

Phào chỉ tường 310



310T



310VG



310-002



310-001



310V



310-007

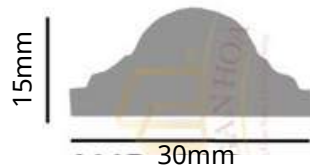

15*30*2440 mm

27.400đ/md

67.000đ/thanh



Phào Chỉ Trang Trí PS

Phào chỉ tường 161

MẪU TRƠN



161-152



161T



161V

MẪU HOA VĂN



161-1T



1452-1



161TV

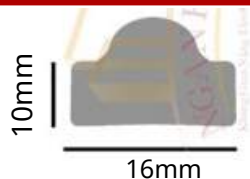

10*16*2440 mm

21.000đ/md

27.400đ/md

51.000đ/thanh

67.000đ/thanh



Phào Chỉ Trang Trí PS

Phào chỉ tường 410

MẪU TRƠN



410T



410-001



410-002

MẪU HOA VĂN



410-3



2614-3



2614-1

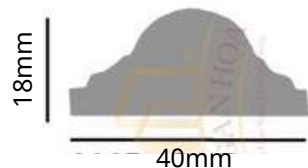

18*40*2440 mm

30.000đ/md

36.800đ/md

73.000đ/thanh

90.000đ/thanh



Phào Chỉ Trang Trí PS

Phào cửa 180

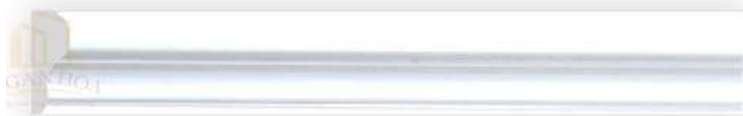

180T



180V



180-002



180VG

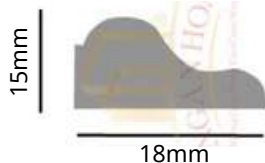

15*18*2440 mm

23.700đ/md

58.000đ/thanh



Phào Chỉ Trang Trí PS

Phào cửa 250



250T



250VG



250V



250-002

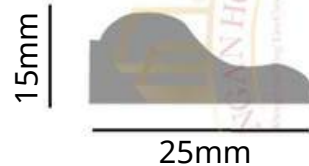

15*25*2440 mm

25.400đ/md

62.000đ/thanh



Phào Chỉ Trang Trí PS

Phào cửa 2091

MẪU TRƠN

MẪU HOA VĂN



2091T



2091-001



2091-002



2091-3

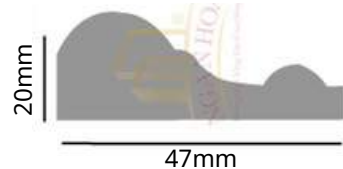

20*47*2440 mm

36.800đ/md

43.800đ/md

90.000đ/thanh

107.000đ/thanh



Phào Chỉ Trang Trí PS

Phào cửa 6010

MẪU TRƠN

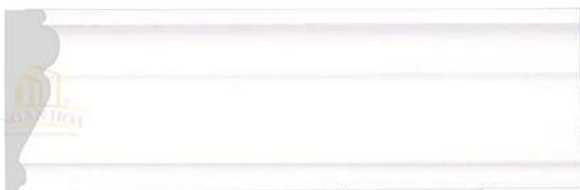

6010T



6010-001



6010-002

MẪU HOA VĂN



6010TV



6010HV



6010 - 70672

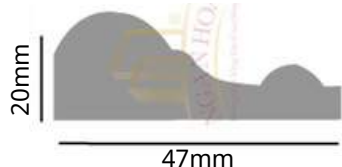

20*47*2440 mm

57.377đ/md

64.300đ/md

140.000đ/thanh

157.000đ/thanh



Phào Chỉ Trang Trí PS

Phào cửa 9010

MẪU TRƠN

MẪU HOA VĂN

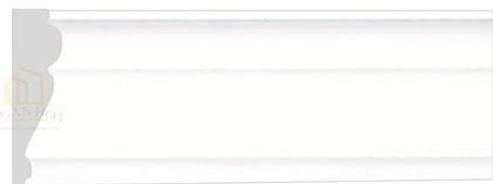

9010T



9010TV



9010-002



9010HV



9010VG



9010-002HVV

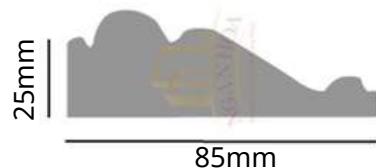

25*85*2440 mm

66.300đ/md

72.900đ/md

162.000đ/thanh

178.000đ/thanh



Phào Chỉ Trang Trí PS

Phào cổ trần 100

MẪU TRƠN



100T



152-1



001



100VG



002



007

MẪU HOA VĂN



100TV



70672



001
HVV



100HV



002
HVV



100-1TV

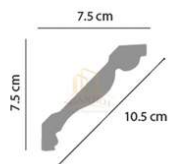

16*105*2440 mm

84.800đ/md

88.900đ/md

207.000đ/thanh

217.000đ/thanh

Phào cổ trần 115



115T



115V



115VG



115-002

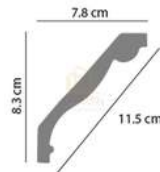

19*115*2440 mm

95.400đ/md

233.000đ/thanh



Phào Chỉ Trang Trí PS

Phào cổ trần 900

MẪU TRƠN



900T



900-VG



900-002

MẪU HOA VĂN



900TV



900-9TV



900-002HVV

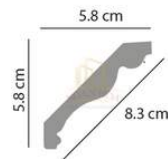

13*83*2440 mm

68.400đ/md

75.000đ/md

167.000đ/thanh

183.000đ/thanh



Phào Chỉ Trang Trí PS

Phào cổ trần 9313

MẪU TRƠN



9313T



9313-152

MẪU HOA VĂN



9313-3



9313VG

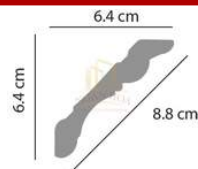

13*88*2440 mm

70.900đ/md

77.800đ/md

173.000đ/thanh

190.000đ/thanh



Phào Chỉ Trang Trí PS

Phào chân tường

PHÀO CHÂN TƯỜNG 85050



15*95*2440 mm

52.000đ/md

127.000đ/thanh

PHÀO CHÂN TƯỜNG 802



13*90*2440 mm

50.400đ/md

123.000đ/thanh



Phụ Kiện Trang Trí

Nẹp kết thúc bậc thềm/ mũi cầu thang

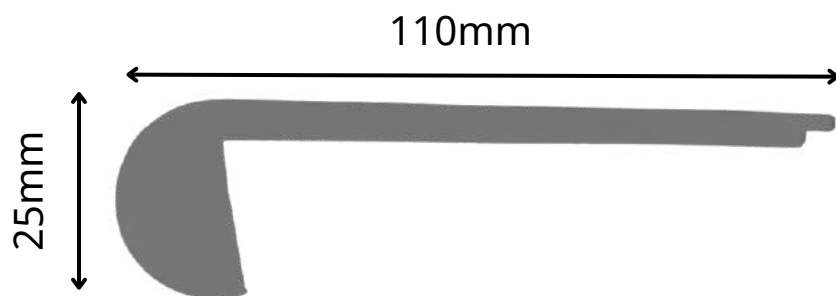

25*110*2400 mm

Mét dài

Thanh

129.000đ

315.000đ

*Đơn giá m2 thi công hoàn thiện chỉ là tạm tính



Phụ Kiện Trang Trí

Phào chân tường 15*100



43A



37A



44A



26A

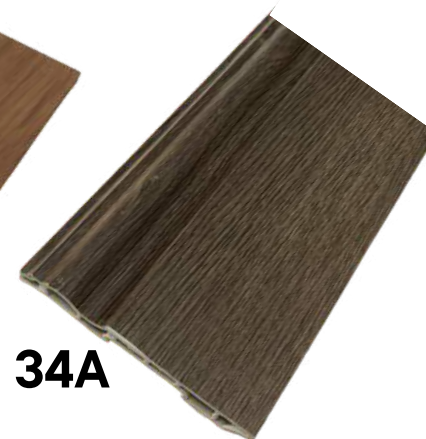

34A



SA11



SA15



SA17



SA61



SA110

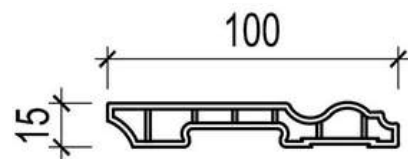

15 x 100 x 3000 mm

69.000đ/md

207.000đ/thanh



Phụ Kiện Trang Trí

Phào chân tường 17*100



M024



M012



9042



M022



8626



8933



8695



8782



W247

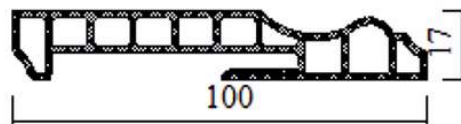

17 x 100 x 3000 mm

86.000đ/md

258.000đ/thanh



Phụ Kiện Trang Trí

Len chân tường PVC



A-00



A-02



A-03



A-04



A-05



A-08



A-10



A-11



A-12



A-13

14 x 78 x 2500 mm

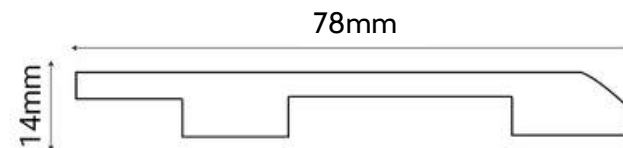

35.600đ/md

89.000đ/thanh

PHÀO V DƯƠNG 25

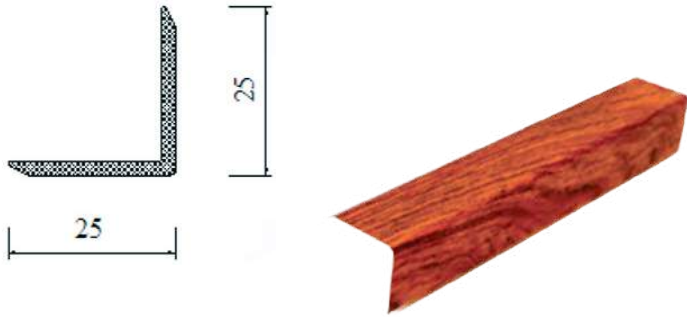

25 x 25 x3000 mm

PHÀO V DƯƠNG 30

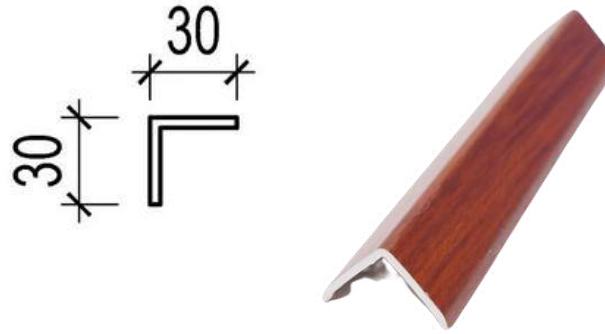

30 x 30 x3000 mm

PHÀO V DƯƠNG 36

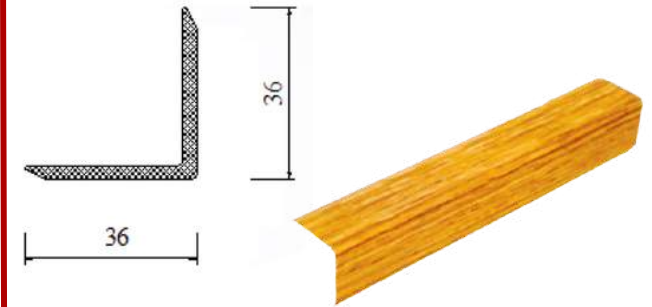

36 x 36 x3000 mm

39.000đ/md

39.000đ/md

49.000đ/md

117.000đ/thanh

117.000đ/thanh

147.000đ/thanh

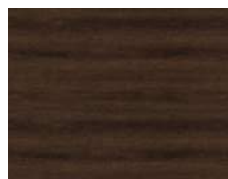

PHÀO V ÂM 25

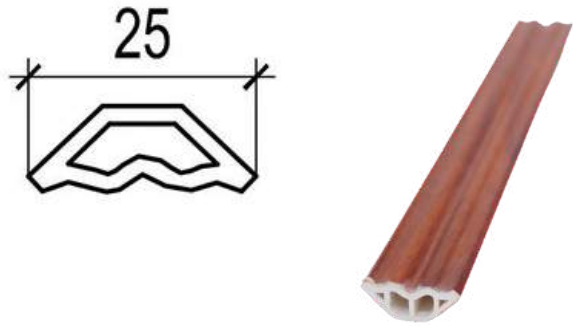

10 x 25 x 3000 mm

PHÀO V ÂM 25

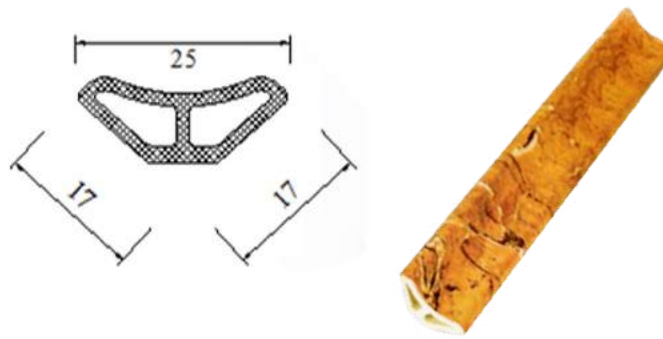

10 x 25 x 3000 mm

PHÀO V ÂM 40

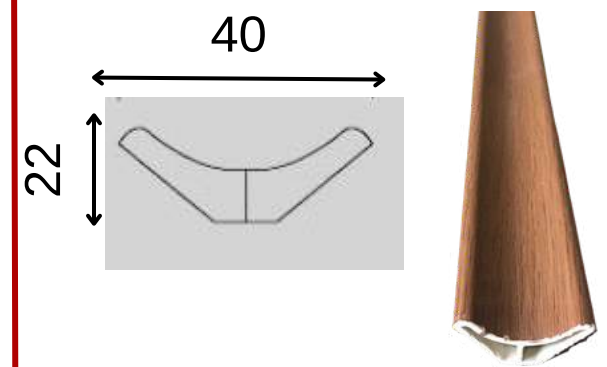

22 x 40 x 3000 mm

29.000đ/md

29.000đ/md

40.000đ/md

87.000đ/thanh

87.000đ/thanh

120.000đ/thanh



PHÀO CHỈ LƯNG PS 60



15 x 60 x3000 mm

70.000đ/md

210.000đ/thanh

PHÀO CHỈ LƯNG SPC 40



32 x 40 x3000 mm

79.000đ/md

237.000đ/thanh

PHÀO CHỈ LƯNG SPC 68



40 x 68 x3000 mm

89.000đ/md

267.000đ/thanh



PHÀO CỔ TRẦN 70

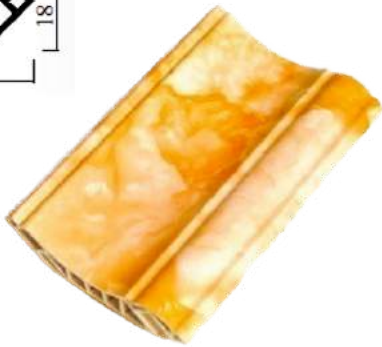
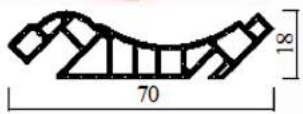

18 x 70 x 3000 mm

PHÀO CỔ TRẦN 100*25

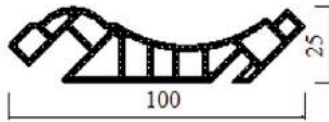

25 x 100 x 3000 mm

PHÀO CỔ TRẦN 100*26

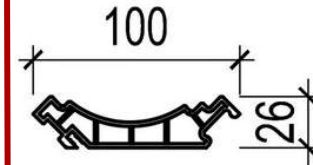

26 x 100 x 3000 mm

79.000đ/md

86.000đ/md

89.000đ/md

237.000đ/thanh

258.000đ/thanh

267.000đ/thanh



PHÀO PHÂN VỊ 45	PHÀO PHÂN VỊ 60	PHÀO CÂN 35	PHÀO CÂN 60
			
20 x 45 x 3000 mm	23,5 x 60 x 3000 mm	18.5 x 35 x 3000 mm	20 x 60 x 3000 mm
49.000đ/md	68.000đ/md	39.000đ/md	75.000đ/md
147.000đ/thanh	204.000đ/thanh	117.000đ/thanh	225.000đ/thanh





Phụ Kiện Trang Trí

Nẹp nhựa L kết thúc

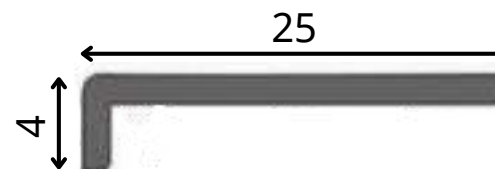

4 x 25 x 2700 mm

21.800đ/md

59.000đ/thanh



Phụ Kiện Trang Trí

Nẹp nhựa F kết thúc



229



005



102



151



004



130



132

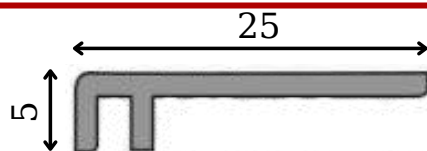

5 x 25 x 2700 mm

29.200đ/md

79.000đ/thanh



Phụ Kiện Trang Trí

Nẹp T inox trang trí (sàn, tường, trần)

Nẹp T8 INOX



8 x 6 x 2500 mm

72.000đ/thanh

Nẹp T10 INOX



10 x 6 x 2500 mm

92.000đ/thanh

Nẹp T15 INOX



15 x 8 x 2500 mm

120.000đ/thanh

Nẹp T20 INOX



20 x 8 x 2500 mm

158.000đ/thanh

NẸP V10 INOX



10 x 10 x 2500 mm

68.000đ/thanh

NẸP V15 INOX



15 x 15 x 2500 mm

80.000đ/thanh

NẸP V20 INOX



20 x 20 x 2500 mm

96.000đ/thanh



Phụ Kiện Trang Trí

Nẹp V Inox trang trí (sàn, tường, trần)

NẸP V25 INOX



25 x 25 x 2500 mm

124.000đ/thanh

NẸP V30 INOX



30 x 30 x 2500 mm

152.000đ/thanh



Phào Kiến Trang Trí

Nẹp La Inox Cuộn Trang Trí (tường, trần)



PHÂN LOẠI	GIÁ
La 10mm/1cm	9.000đ/md
La 15mm/1.5cm	13.000đ/md
La 20mm/2cm	17.000/md
La 30mm/3cm	24.000đ/md
La 40mm/4cm	32.000đ/md
La 50mm/5cm	43.000đ/md
La 60mm/6cm	51.000đ/md
La 70mm/7cm	60.000đ/md
La 80mm/9cm	66.000đ/md
La 100mm/10cm	79.000đ/md

KEO INCO



300ml

55.000đ/chai

1.320.000đ/thùng (24 chai)

KE/BÁT INOX



5 x 33 x 45 mm

1.200đ/cái

120.000đ/bịch (100 cái)